

# KOMATSU®

## PC300LC-8

**NET HORSEPOWER**  
184 kW **246 HP** @ 1950 rpm

**OPERATING WEIGHT**  
34969–35902 kg  
**77,093–79,152 lb**

**BUCKET CAPACITY**  
0.68–1.96 m<sup>3</sup> **0.89–2.56 yd<sup>3</sup>**

**PC**  
**300**  
**LC**



HYDRAULIC EXCAVATOR

Photo may include optional equipment.

# WALK-AROUND

## *Productivity Features*

### ● **High Production and Low Fuel Consumption**

Powerful working performance and fuel efficiency increase production and lower fuel costs.

### ● **Large Drawbar Pull**

provides excellent steering and slope climbing performance.

### ● **Higher Lifting Capacity**

Lifting mode is provided for increased lifting operation.

### ● **Large Digging Force**

Pressing the Power Max function button temporarily increases digging force by 8%.

### ● **Multi-Function Color Monitor**

- Working mode selection
- Self-diagnostic with EMMS
- Attachment hydraulic oil flow adjustment in cab

### ● **Automatic Three Speed Travel**

### ● **General Features**

- Operator Protective Guard (OPG) top guard level 2 capable with optional bolt on top guard
- Engine neutral start with lock lever
- Slip-resistant plates for improved foot grip
- New cab design for hydraulic excavators

## *Easy Maintenance*

- Extended replacement interval of engine oil, engine oil filter, and hydraulic filter
- Equipped with 10 micron fuel pre-filter as standard (with water separator)
- Side-by-side cooling concept enables individual cooling modules to be serviced
- Equipped with the EMMS monitoring system
- Easy access to engine oil filter and fuel drain valve
- Large fuel tank capacity
- Equipped with KOMTRAX® (standard)



KOMTRAX equipped machines can send location, SMR and operation maps to a secure website utilizing wireless technology. Machines also relay error codes, cautions, maintenance items, fuel levels, and much more.

**NET HORSEPOWER**184 kW **246 HP** @ 1950 rpm**OPERATING WEIGHT**

34969 – 35902 kg

**77,093 – 79,152 lb****BUCKET CAPACITY**0.68 – 1.96 m<sup>3</sup>**0.89 – 2.56 yd<sup>3</sup>*****Ecology and Economy Features***

- Low emission engine
- A powerful turbocharged and air-to-air aftercooled Komatsu SAA6D114E-3 engine provides 184 kW **246 HP** (net). This engine is EPA Tier 3 and EU stage 3A emissions certified without sacrificing power or machine productivity.
- Economy mode reduces fuel consumption
- Low operation noise

***Large Comfortable Cab***

- Exceptionally low-noise cab
- Low vibration with cab damper mounting
- Highly pressurized cab with automatic air conditioner
- Operator seat and console with armrest enables adjustment to the proper operational position

***Excellent Reliability and Durability***

- High rigidity work equipment
- Sturdy frame structure
- Reliable Komatsu manufactured major components
- Highly reliable electronic devices

***Large TFT LCD Monitor***

- Large, easy-to-use, 7" multi-color monitor
- Can be displayed in ten languages for global support

TFT: Thin Film Transistor  
LCD: Liquid Crystal Display

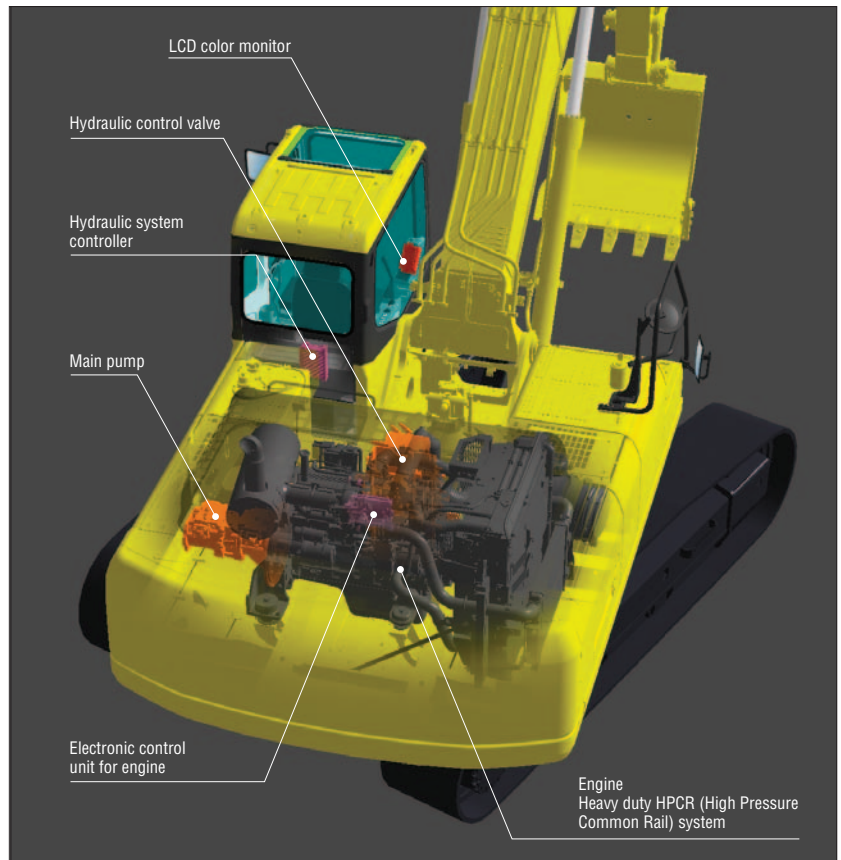

Photo may include optional equipment.

## PRODUCTIVITY FEATURES



Komatsu's new "ecot3" engines are designed to deliver optimum performance under the toughest of conditions, while meeting the latest environmental regulations. This engine is EPA Tier 3 and EU Stage 3A emissions certified; "ecot3" - ecology and economy combined with Komatsu technology to create a high performance engine without sacrificing power or productivity.



### Environment-Friendly Clean Engine

The PC300LC-8 gets its exceptional power and work capacity from a Komatsu SAA6D114E-3 engine. Net output is 184 kW **246 HP**, providing increased hydraulic power and improved fuel efficiency.

The Komatsu SAA6D114E-3 is EPA Tier 3 and EU stage 3A emissions certified with NOx emission reduced by 33%. The SAA6D114E-3 engine adopts the electronically controlled Heavy Duty HPCR\* fuel injection system.

\*HPCR: High Pressure Common Rail

### Hydraulics

Unique two-pump system ensures smooth compound movement of the work equipment. HydrauMind controls both pumps for efficient engine power use. This system also reduces hydraulic loss during operation.

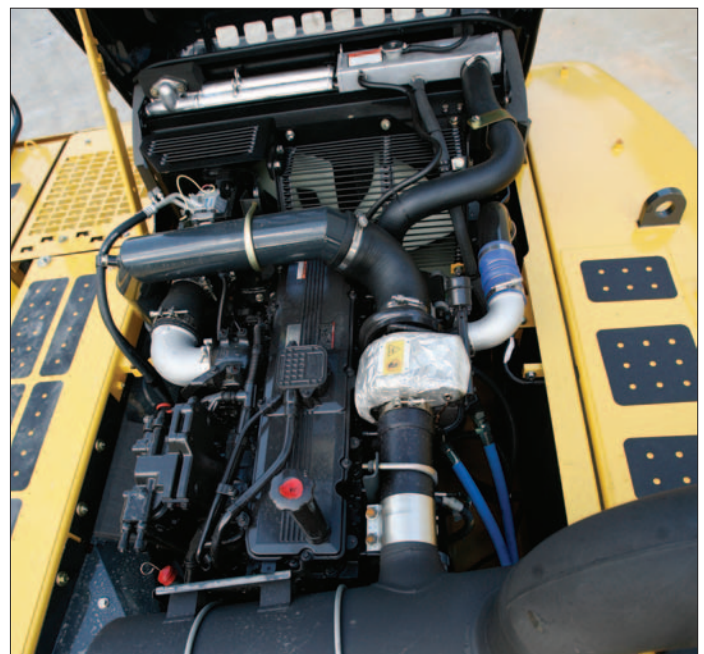

**Large Maximum Drawbar Pull**

Large maximum drawbar pull provides superb steering and slope climbing performance.

Maximum drawbar pull: 264 kN 26900 kgf **59,300 lb**

**Large Digging Force**

With the one-touch Power Max function, digging force is further increased (8.5 seconds of operation).

**Maximum arm crowd force (ISO):**

160 kN (16.3t) ➔ **171 kN (17.4t) 8% UP**  
with Power Max.

**Maximum bucket digging force (ISO):**

212 kN (21.6t) ➔ **227 kN (23.1t) 8% UP**  
with Power Max.

\*Measured with Power Max function, 3185 mm 10'5" arm and ISO rating.

**Smooth Loading Operation**

Two return hoses improve hydraulic performance. In the arm out function, a portion of the oil is returned directly to the tank for smooth operation.



**Two Boom Settings**

Smooth mode provides easy operation for fine work or scraping down operation. When maximum digging force is needed, switch to Power mode for more effective excavating.

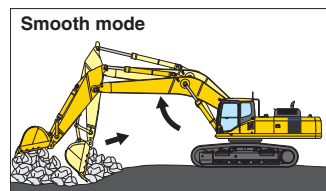

Smooth mode  
Boom floats upward, reducing lifting of machine front. This facilitates fine work and scraping down operations.

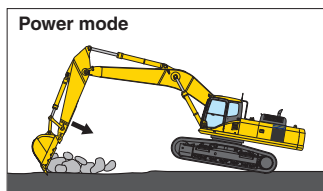

Power mode  
Boom force is at maximum for normal production digging.

**Automatic Three-Speed Travel**

Travel speed is automatically shifted from high to low speed according to the pressure demand on travel circuit.

**Working Mode Selection**

The PC300LC-8 excavator is equipped with five working modes (P, E, L, B, and ATT mode). Each mode is designed to match engine speed, pump flow, and system pressure with the current application. This provides the flexibility to match equipment performance to the job at hand.

Working Mode	Application	Advantage
P	Power mode	<ul style="list-style-type: none"> <li>Maximum production/power</li> <li>Fast cycle times</li> </ul>
E	Economy mode	<ul style="list-style-type: none"> <li>Excellent fuel economy</li> </ul>
L	Lifting mode	<ul style="list-style-type: none"> <li>Hydraulic pressure is increased by 7%</li> </ul>
B	Breaker mode	<ul style="list-style-type: none"> <li>Optimum engine rpm, hydraulic flow, 1-way</li> </ul>
ATT	Attachment mode	<ul style="list-style-type: none"> <li>Optimum engine rpm, hydraulic flow, 2-way</li> </ul>

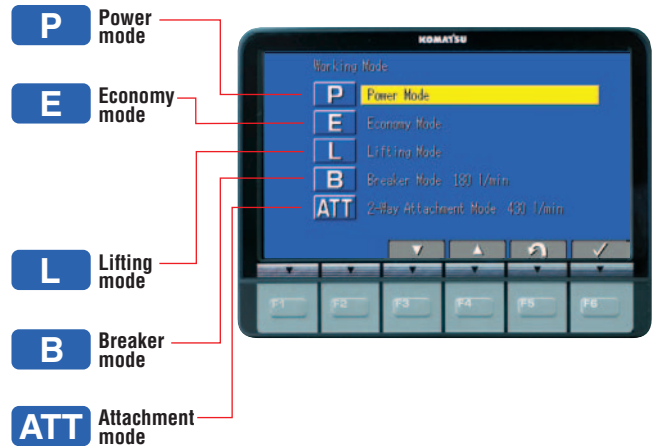

**Power/Economy Modes**

The PC300LC-8 offers two operator selectable working modes. Power mode for severe or high production applications. Economy mode allows significant fuel savings at slightly reduced production levels.

**Lifting Mode**

When the lifting mode is selected, lifting capacity is increased 7% by raising hydraulic pressure.

## WORKING ENVIRONMENT



### Low Cab Noise

The newly-designed cab is highly rigid and has excellent sound absorption ability. Through improvement of noise source reduction and use of a low noise engine, hydraulic equipment, and air conditioner, this machine generates a low level of noise similar to that of a modern automobile.

### Low Vibration with Cab Damper Mounting

PC300LC-8 uses a multi-layer viscous mount system that incorporates a longer stroke and the addition of a spring. The new cab damper mounting combined with a high rigidity deck aids vibration reduction at the operator seat.

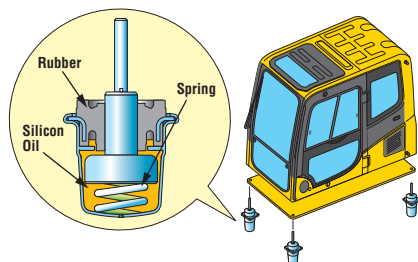

### Wide Newly-Designed Cab

Newly-designed wide spacious cab includes high-back seat with reclining backrest. The seat height and longitudinal inclination are easily adjusted using a pull-up lever. You can set the appropriate operational posture of the armrest together with the console. Reclining the seat further enables you to place it into the fully flat state with the headrest attached.



### Pressurized Cab

Automatic air conditioner, air filter, and a higher internal air pressure (+6.0 mm Aq +0.2" Aq) help minimize external dust from entering the cab.

### Automatic Air Conditioner

Enables you to easily and precisely set cab atmosphere with the simple touch pad controls on the large LCD. The bi-level control function improves air flow and keeps the operator comfortable throughout the year. Defroster function keeps the cab glass clear.

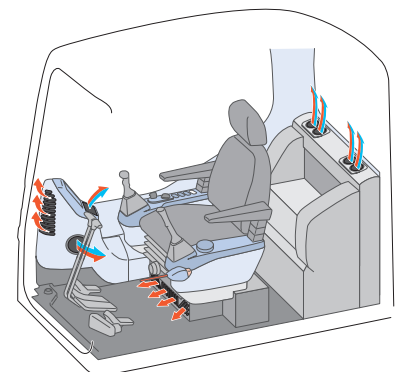

# GENERAL FEATURES

### New Cab Design for Hydraulic Excavators

The cab is designed specifically for hydraulic excavators and gains reinforced strength from the pipe-structured cab framework. The cab framework provides high durability and impact resistance with very high impact absorbency.



### Slip-Resistant Plates

Highly durable slip-resistant plates maintain excellent foot traction performance for the long term.



### Lock Lever

Makes all hydraulic cab controls inoperable when placed in lock position. Neutral start function allows the machine to be started only in the lock position.



*Lock Lever in Lock Position*

### Large Side-View Mirrors

Large left-side mirror with the addition of right side mirrors allow the operator to see both sides of the machine.



*Operator Protective Guard (OPG) Level 2 Top Guard (optional)*

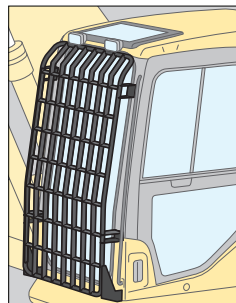

*Front Full Guard Level 2 (optional)*

### Thermal and Fan Guards

Guarding is placed around high-temperature parts of the engine and fan drive.

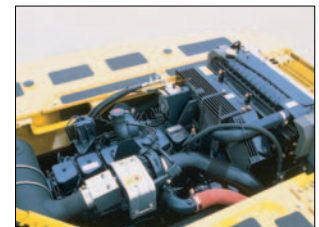

### Increased Cab Glass Area

Highly rigid cab allows for increased glass area and provides superior view of the work area.

### Skylight

Skylight can be opened to improve overhead visibility.



*Large Serrated Steps*

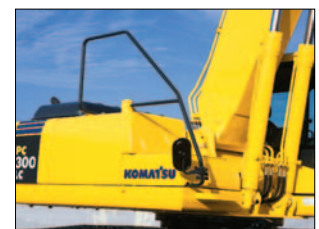

*Hand Rail*

# MAINTENANCE FEATURES

## Self-Diagnostic Monitor

The PC300LC-8 features the most advanced diagnostics system in the industry. The Komatsu-exclusive system identifies maintenance items, reduces diagnostic times, indicates oil and filter replacement hours, and displays error codes.

### Continuous Machine Monitoring System

When the starting switch is turned ON, check-before-starting items and caution items appear on the LCD. If abnormalities are found, a warning lamp blinks and a warning buzzer sounds. The continuous machine condition checks help prevent the development of serious problems and allow the operator to concentrate on the work at hand.

## Easy Maintenance

Komatsu designed the PC300LC-8 to have easy service access. We know by doing this, routine maintenance and servicing are more likely to be performed, which can mean a reduction in costly downtime later on. Here are some of the many service features found on the PC300LC-8.

### Easy Radiator Cleaning

Since the radiator and oil cooler are side-by-side modules, it is easy to clean, remove, and install them.

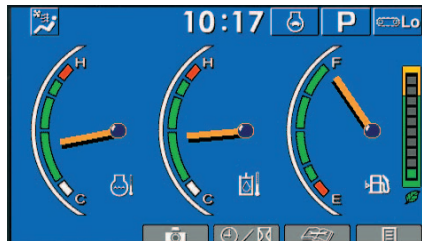

Normal display

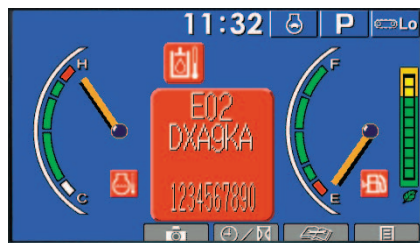

Error code display

### Abnormalities Display with Code

When an abnormality occurs during operation, a user code is displayed. When an important user code is displayed, a caution lamp blinks and a warning buzzer sounds to alert the operator to take action.

### Easy Access to Engine Oil filter and Fuel Drain Valve

Engine oil level check, oil fill port, and fuel filter are one side mounted to improve accessibility. Engine oil filter and fuel drain valve are remotely mounted to improve accessibility.



Maintenance time display

### Oil Maintenance Function

When the machine exceeds the oil or filter replacement time, the oil maintenance monitor will display lights to inform the operator.

### Trouble Data Memory Function

The monitor stores a record of abnormalities for effective troubleshooting.



Engine Oil Filter



Fuel Drain Valve

### Equipped with Fuel Pre-Filter (with Water Separator)

Removes water and contaminants in the fuel to help prevent fuel problems.



### Equipped with the Eco-Drain Valve as Standard

Enables easier and cleaner engine oil changes.



## Maintenance Cost Reduction

### Extended Replacement Intervals for Hydraulic Oil and Filter/Engine Oil and Filter

High performance filters are used in the hydraulic circuit and engine. By increasing the hydraulic oil, hydraulic oil filter, engine oil, and engine oil filter replacement intervals, maintenance costs are significantly reduced.



Engine oil & Engine oil filter every **500** hours  
 Hydraulic oil every **5000** hours  
 Hydraulic oil filter every **1000** hours

### Extended Work Equipment Greasing Interval

High quality BMRC bushings and resin shims are installed in the work equipment, excluding the bucket, which can extend the greasing interval to 500 hours.

### High-Capacity Air Cleaner

High capacity air cleaner is comparable to that of larger machines. The large air cleaner extends filter element life and extends service intervals.



### High-Pressure In-Line Filters

The PC300LC-8 has high pressure in-line filters installed at the pump discharge ports. This provides an additional level of hydraulic system protection.

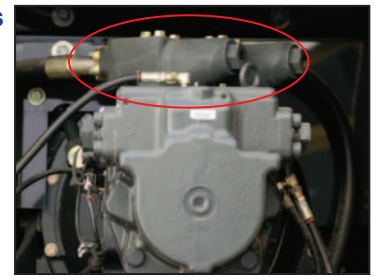
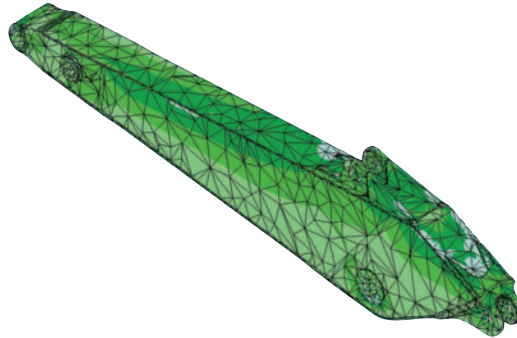

Photo may include optional equipment.

## RELIABILITY FEATURES

### High Rigidity Work Equipment

Thanks to large cross-sectional structures, thick high tensile strength steel, and partition walls, the boom and arm exhibit excellent durability and are highly resistant to bending and torsional stress.



### Sturdy Frame Structure

The revolving frame, center frame, and undercarriage are designed using the most advanced three-dimensional CAD and FEM analysis technology.

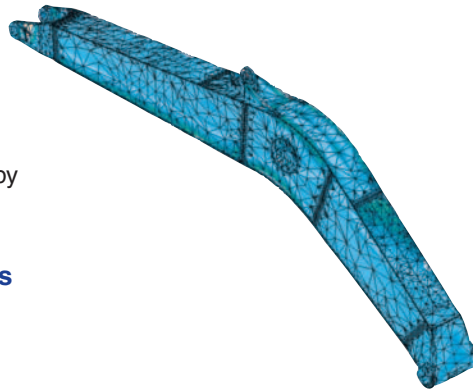

### Reliable Components

All of the major machine components, such as engine, hydraulic pumps, hydraulic motors, and control valves are exclusively designed and manufactured by Komatsu.

### Highly Reliable Electronic Devices

Exclusively designed electronic devices have passed severe testing.

- Controllers
- Sensors
- Connectors
- Wiring

**Metal guard rings protect all the hydraulic cylinders and improve reliability.**

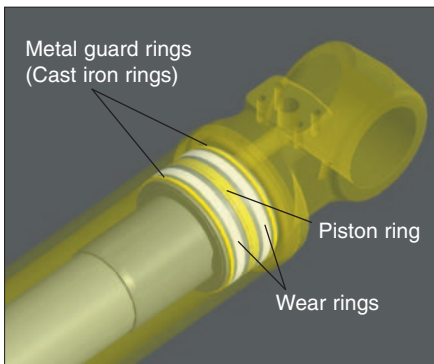

### DT-Type Connectors

DT-type connectors seal tight and have higher reliability.

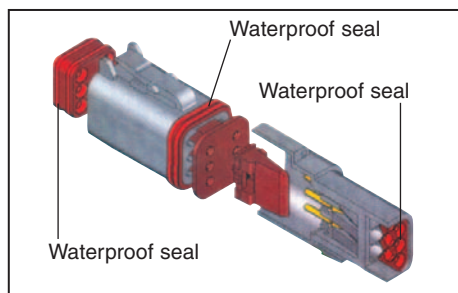

### O-Ring Face Seals

Hydraulic hoses are equipped with O-ring seals versus conventional taper seal, to provide extended leak-free life.

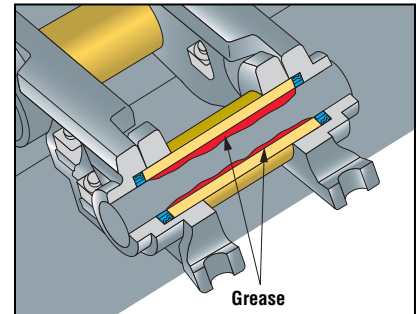

### Grease Sealed Track

PC300LC-8 uses grease sealed tracks for extended undercarriage life.



### Track Link with Strut

PC300LC-8 uses track links with strut providing superb durability.

# Large LCD Color Monitor

## Large Multi-Lingual LCD Monitor

A large user-friendly color monitor enables accurate and smooth work. Improved screen visibility is achieved by use of a TFT liquid crystal display that can easily be read at various angles and lighting conditions. All switches are simple and easy to operate. Industry-first function keys facilitate multi-function operations. Displays data in 10 languages to globally support operators around the world.



**Indicators**

- 1 Auto-decelerator
- 2 Working mode
- 3 Travel speed
- 4 Engine water temperature gauge
- 5 Hydraulic oil temperature gauge
- 6 Fuel gauge
- 7 Eco-gauge
- 8 Function switches menu

**Basic operation switches**

- 1 Auto-decelerator
- 2 Working mode selector
- 3 Travel speed selector
- 4 Buzzer cancel
- 5 Wiper
- 6 Windshield washer

Basic operation switches

Function switches

Air conditioner operation switches

## Rearview Camera Display

On the large LCD color monitor, the operator can access and view one standard video camera that will display areas directly behind the machine. An optional 2 camera system is available.



## Equipment Management Monitoring System (EMMS)

### Monitor Function

Controller monitors engine oil level, coolant temperature, battery charge, air filter clogging, etc. If the controller finds any abnormality, it is displayed on the LCD.



# PC300LC-8 HYDRAULIC EXCAVATOR

## SPECIFICATIONS



### ENGINE

Model ..... Komatsu SAA6D114E-3  
 Type ..... Water-cooled, 4-cycle, direct injection  
 Aspiration ..... Turbocharged and aftercooled  
 Number of cylinders ..... 6  
 Bore ..... 114 mm **4.49"**  
 Stroke ..... 135 mm **5.31"**  
 Piston displacement ..... 8.27 ltr **505 in<sup>3</sup>**  
 Horsepower  
   SAE J1995 ..... Gross 194 kW **260 HP**  
   ISO 9249/SAE J1349 ..... Net 184 kW **246 HP**  
   Rated rpm ..... 1950 rpm  
 Fan drive type ..... Mechanical  
 Governor ..... All-speed, electronic  
 EPA Tier 3 and EU Stage 3A emission certified.



### HYDRAULIC SYSTEM

Type ..... HydrauMind (Hydraulic Mechanical Intelligence New Design) system, closed-center with load sensing and pressure compensated valves  
 Number of selectable working modes ..... 5  
 Main pump:  
   Type ..... Variable displacement piston type  
   Pumps for ..... Boom, arm, bucket, swing, and travel circuits  
   Maximum flow ..... 535 ltr/min **141 U.S. gal/min**  
 Supply for control circuit ..... Self-reducing valve  
 Hydraulic motors:  
   Travel ..... 2 x axial piston motors with parking brake  
   Swing ..... 1 x axial piston motor with swing holding brake  
 Relief valve setting:  
   Implement circuits ..... 37.3 MPa 380 kg/cm<sup>2</sup> **5,400 psi**  
   Travel circuit ..... 37.3 MPa 380 kg/cm<sup>2</sup> **5,400 psi**  
   Swing circuit ..... 27.9 MPa 285 kg/cm<sup>2</sup> **4,050 psi**  
   Pilot circuit ..... 3.2 MPa 33 kg/cm<sup>2</sup> **470 psi**

Hydraulic cylinders:  
 Number of cylinders—bore x stroke x rod diameter  
   Boom ..... 2 – 140 mm x 1480 mm x 100 mm **5.5" x 58.3" x 3.9"**  
   Arm ..... 1 – 160 mm x 1825 mm x 110 mm **6.3" x 71.9" x 4.3"**  
   Bucket ..... for 3.2 m **10'5"** and 4.0 m **13'2"** Arms  
     1-140 mm x 1285 mm x 100 mm **5.5" x 50.6" x 3.9"**  
     for 2.54 m **8'4"** Arm  
     1-150 mm x 1285 mm x 110 mm **5.9" x 50.6" x 4.3"**



### DRIVES AND BRAKES

Steering control ..... Two levers with pedals  
 Drive method ..... Hydrostatic  
 Maximum drawbar pull ..... 264 kN 26900 kg **59,300 lb**  
 Gradeability ..... 70%, 35°  
 Maximum travel speed: High ..... 5.5 km/h **3.4 mph**  
   (Auto-shift) Mid ..... 4.5 km/h **2.8 mph**  
   Low ..... 3.2 km/h **2.0 mph**  
 Service brake ..... Hydraulic lock  
 Parking brake ..... Mechanical disc brake



### SWING SYSTEM

Drive method ..... Hydrostatic  
 Swing reduction ..... Planetary gear  
 Swing circle lubrication ..... Grease bathed  
 Service brake ..... Hydraulic lock  
 Holding brake/Swing lock ..... Mechanical disc brake  
 Swing speed ..... 9.5 rpm  
 Swing torque ..... 11386 kg·m **82,313 ft. lbs.**



### UNDERCARRIAGE

Center frame ..... X-frame  
 Track frame ..... Box-section  
 Track type ..... Sealed  
 Track adjuster ..... Hydraulic  
 No. of shoes ..... 48 each side  
 No. of carrier rollers ..... 2 each side  
 No. of track rollers ..... 8 each side



### COOLANT AND LUBRICANT CAPACITY (REFILLING)

Fuel tank ..... 605 ltr **160 U.S. gal**  
 Coolant ..... 30.3 ltr **8.0 U.S. gal**  
 Engine ..... 35.0 ltr **9.2 U.S. gal**  
 Final drive, each side ..... 8.5 ltr **2.2 U.S. gal**  
 Swing drive ..... 13.4 ltr **3.5 U.S. gal**  
 Hydraulic tank ..... 188 ltr **49.7 U.S. gal**



### OPERATING WEIGHT (APPROXIMATE)

Operating weight, including 6500 mm **21'3"** one-piece boom, 3185 mm **10'5"** arm, SAE heaped 1.96 m<sup>3</sup> **2.56 yd<sup>3</sup>** bucket, rated capacity of lubricants, coolant, full fuel tank, operator, and standard equipment.

Triple-Grouser Shoes	Operating Weight	Ground Pressure
700 mm <b>28"</b>	34991 kg <b>77,142 lb</b>	0.58 kg/cm <sup>2</sup> <b>8.20 psi</b>
800 mm <b>31.5"</b>	35371 kg <b>77,980 lb</b>	0.51 kg/cm <sup>2</sup> <b>7.30 psi</b>
850 mm <b>33.5"</b>	35751 kg <b>78,817 lb</b>	0.49 kg/cm <sup>2</sup> <b>6.90 psi</b>



### WORKING FORCES

	Arm	2540 mm <b>8'4"</b>	3185 mm <b>10'5"</b>	4020 mm <b>13'2"</b>
SAE rating	Bucket digging force at power max.	23300 kgf <b>51,370 lb</b>	20400 kgf <b>44,970 lb</b>	20400 kgf <b>44,970 lb</b>
	Arm crowd force at power max.	19700 kgf <b>43,430 lb</b>	16800 kgf <b>37,040 lb</b>	14200 kgf <b>31,310 lb</b>
ISO rating	Bucket digging force at power max.	26400 kgf <b>58,200 lb</b>	23100 kgf <b>50,930 lb</b>	23100 kgf <b>50,930 lb</b>
	Arm crowd force at power max.	20500 kgf <b>45,190 lb</b>	17400 kgf <b>38,360 lb</b>	14700 kgf <b>32,410 lb</b>



**DIMENSIONS**

	Arm Length	2540 mm <b>8'4"</b>	3185 mm <b>10'5"</b>	4020 mm <b>13'2"</b>
<b>A</b>	Overall length	11180 mm <b>36'8"</b>	11140 mm <b>36'7"</b>	11170 mm <b>36'8"</b>
<b>B</b>	Length on ground (transport):	6760 mm <b>22'2"</b>	5930 mm <b>19'5"</b>	5475 mm <b>18'0"</b>
<b>C</b>	Overall height (to top of boom)	3410 mm <b>11'2"</b>	3280 mm <b>10'9"</b>	3760 mm <b>12'4"</b>
<b>D</b>	Overall width	3440 mm <b>11'4"</b>		
<b>E</b>	Overall height (to top of cab)	3130 mm <b>10'3"</b>		
<b>F</b>	Ground clearance, counterweight	1185 mm <b>3'11"</b>		
<b>G</b>	Ground clearance (minimum)	500 mm <b>1'8"</b>		
<b>H</b>	Tail swing radius	3450 mm <b>11'4"</b>		
<b>I</b>	Track length on ground	4030 mm <b>13'3"</b>		
<b>J</b>	Track length	4955 mm <b>16'3"</b>		
<b>K</b>	Track gauge	2590 mm <b>8'6"</b>		
<b>L</b>	Width of crawler	3440 mm <b>11'4"</b>		
<b>M</b>	Shoe width	850 mm <b>33.5"</b>		
<b>N</b>	Grouser height	36 mm <b>1.4"</b>		
<b>O</b>	Machine cab height	2580 mm <b>8'6"</b>		
<b>P</b>	Machine cab width	2995 mm <b>9'10"</b>		
<b>Q</b>	Distance, swing center to rear end	3405 mm <b>11'2"</b>		

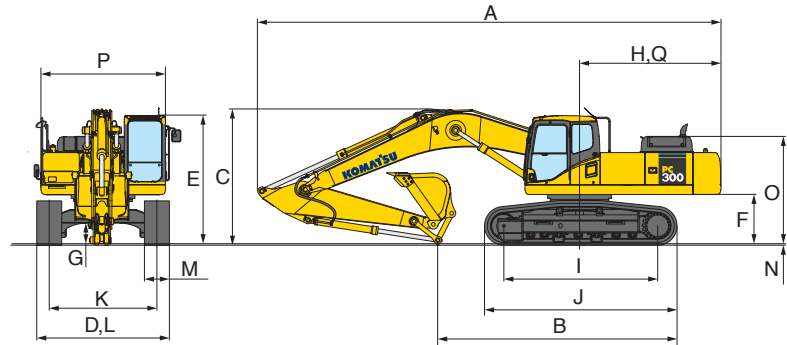

**BACKHOE BUCKET, ARM, AND BOOM COMBINATION**

Bucket Type	Bucket			Arms		
	Capacity	Width	Weight	2540 mm 8'4"	3185 mm 10'5"	4020 mm 13'2"
Komatsu TL	0.93 m <sup>3</sup> <b>1.21 yd<sup>3</sup></b>	762 mm <b>30"</b>	1097 kg <b>2,418 lb</b>	V	V	V
	1.18 m <sup>3</sup> <b>1.54 yd<sup>3</sup></b>	914 mm <b>36"</b>	1198 kg <b>2,641 lb</b>	V	V	V
	1.44 m <sup>3</sup> <b>1.88 yd<sup>3</sup></b>	1067 mm <b>42"</b>	1325 kg <b>2,921 lb</b>	V	V	V
	1.70 m <sup>3</sup> <b>2.22 yd<sup>3</sup></b>	1219 mm <b>48"</b>	1426 kg <b>3,144 lb</b>	V	V	W
	1.96 m <sup>3</sup> <b>2.56 yd<sup>3</sup></b>	1372 mm <b>54"</b>	1554 kg <b>3,425 lb</b>	W	W	X
Komatsu HP	0.68 m <sup>3</sup> <b>0.89 yd<sup>3</sup></b>	610 mm <b>24"</b>	1022 kg <b>2,254 lb</b>	V	V	V
	0.93 m <sup>3</sup> <b>1.21 yd<sup>3</sup></b>	762 mm <b>30"</b>	1178 kg <b>2,598 lb</b>	V	V	V
	1.18 m <sup>3</sup> <b>1.54 yd<sup>3</sup></b>	914 mm <b>36"</b>	1358 kg <b>2,993 lb</b>	V	V	V
	1.44 m <sup>3</sup> <b>1.88 yd<sup>3</sup></b>	1067 mm <b>42"</b>	1439 kg <b>3,173 lb</b>	V	V	V
	1.70 m <sup>3</sup> <b>2.22 yd<sup>3</sup></b>	1219 mm <b>48"</b>	1555 kg <b>3,429 lb</b>	V	V	X
Komatsu HPS	0.68 m <sup>3</sup> <b>0.89 yd<sup>3</sup></b>	610 mm <b>24"</b>	1112 kg <b>2,451 lb</b>	V	V	V
	0.93 m <sup>3</sup> <b>1.21 yd<sup>3</sup></b>	762 mm <b>30"</b>	1294 kg <b>2,853 lb</b>	V	V	V
	1.18 m <sup>3</sup> <b>1.54 yd<sup>3</sup></b>	914 mm <b>36"</b>	1437 kg <b>3,167 lb</b>	V	V	V
	1.44 m <sup>3</sup> <b>1.88 yd<sup>3</sup></b>	1067 mm <b>42"</b>	1607 kg <b>3,543 lb</b>	V	V	W
	1.70 m <sup>3</sup> <b>2.22 yd<sup>3</sup></b>	1219 mm <b>48"</b>	1750 kg <b>3,857 lb</b>	V	W	X
Komatsu HPX	0.68 m <sup>3</sup> <b>0.89 yd<sup>3</sup></b>	610 mm <b>24"</b>	1239 kg <b>2,731 lb</b>	V	V	V
	0.93 m <sup>3</sup> <b>1.21 yd<sup>3</sup></b>	762 mm <b>30"</b>	1421 kg <b>3,133 lb</b>	V	V	V
	1.18 m <sup>3</sup> <b>1.54 yd<sup>3</sup></b>	914 mm <b>36"</b>	1564 kg <b>3,447 lb</b>	V	V	V
	1.44 m <sup>3</sup> <b>1.88 yd<sup>3</sup></b>	1067 mm <b>42"</b>	1734 kg <b>3,823 lb</b>	V	V	W
	1.70 m <sup>3</sup> <b>2.22 yd<sup>3</sup></b>	1219 mm <b>48"</b>	1877 kg <b>4,137 lb</b>	V	W	X
	1.96 m <sup>3</sup> <b>2.56 yd<sup>3</sup></b>	1372 mm <b>54"</b>	2048 kg <b>4,516 lb</b>	X	X	Y

V – Used with densities up to 3,500 lb/yc<sup>3</sup>, W – Used with densities up to 3,000 lb/yc<sup>3</sup>  
 X – Used with densities up to 2,500 lb/yc<sup>3</sup>, Y – Used with densities up to 2,000 lb/yc<sup>3</sup>, Z – Not useable

# WORKING RANGES



WORKING RANGE

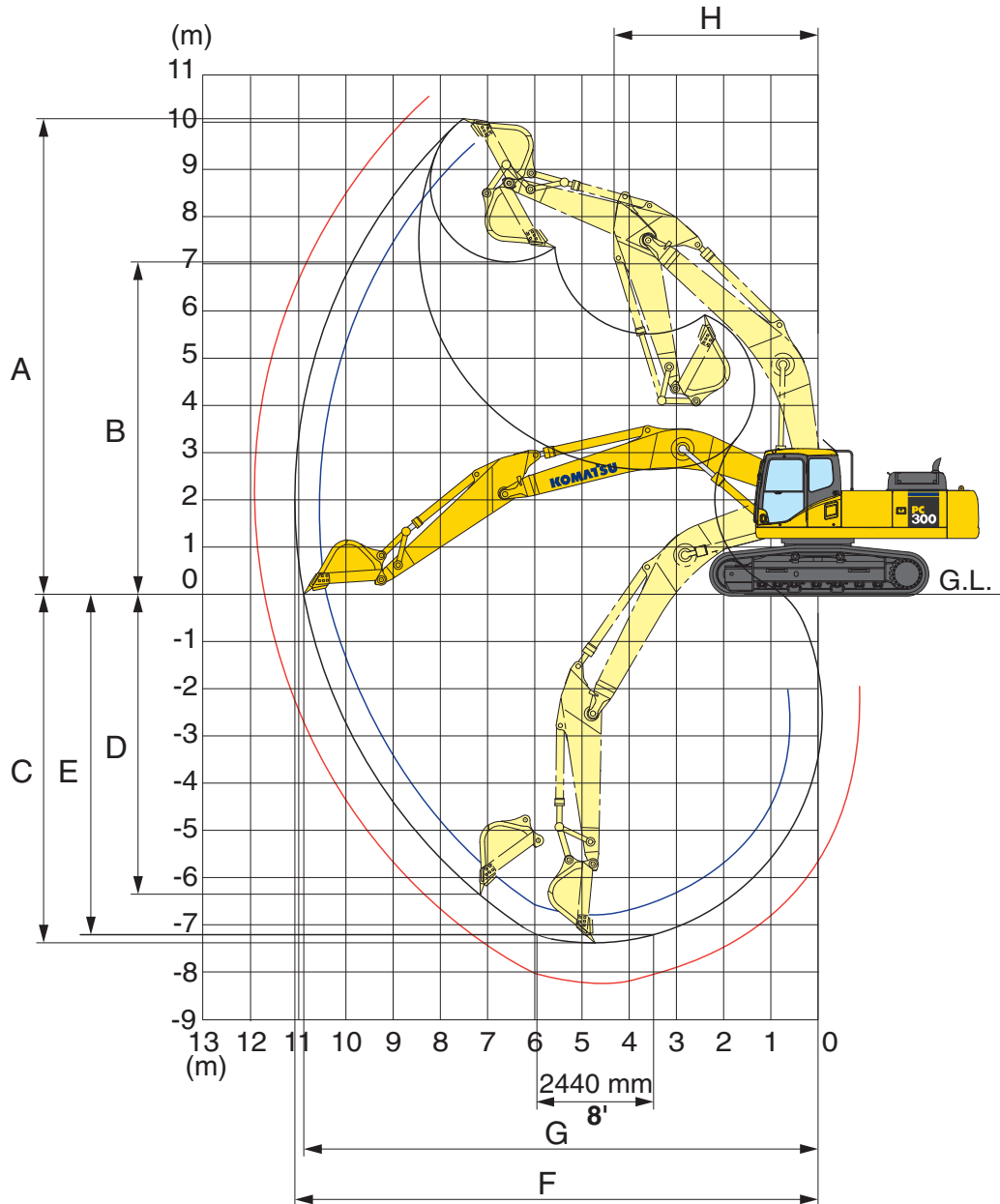

	Arm	2540 mm 8'4"	3185 mm 10'5"	4020 mm 13'2"
A	Max. digging height	9965 mm 32'8"	10210 mm 33'6"	10550 mm 34'7"
B	Max. dumping height	6895 mm 22'7"	7110 mm 23'4"	7490 mm 24'7"
C	Max. digging depth	6705 mm 22'0"	7380 mm 24'3"	8180 mm 26'10"
D	Max. vertical wall digging depth	5880 mm 19'4"	6480 mm 21'3"	7280 mm 23'11"
E	Max. digging depth of cut for 8' level	6520 mm 21'5"	7180 mm 23'7"	8045 mm 26'5"
F	Max. digging reach	10550 mm 34'7"	11100 mm 36'5"	11900 mm 39'1"
G	Max. digging reach at ground level	10355 mm 34'0"	10920 mm 35'10"	11730 mm 38'6"
H	Min. swing radius	4400 mm 14'5"	4310 mm 14'2"	4320 mm 14'2"

# LIFTING CAPACITIES



### LIFTING CAPACITY

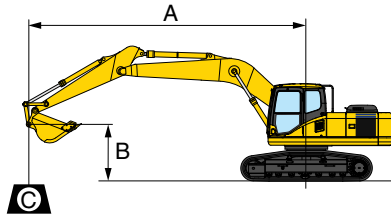

- A: Reach from swing center
- B: Bucket hook height
- C: Lifting capacity
- Cf: Rating over front
- Cs: Rating over side
- ⊗ : Rating at maximum reach

Conditions:

- Arm: 2540 mm 8'4"
- Boom length 6500 mm 21'3"
- Bucket 1.4 m<sup>3</sup> 1.83 yd<sup>3</sup> (SAE heaped)
- Bucket weight: 1014 kg 2,235 lb.

PC300LC-8		Shoe 800 mm 31.5"										Unit: kg/lb	
B	A MAX	3.0 m 10'		4.6 m 15'		6.1 m 20'		7.6 m 25'		9.1 m 30'		⊗ MAX	
		Cf	Cs	Cf	Cs	Cf	Cs	Cf	Cs	Cf	Cs	Cf	Cs
7.6 m 25'	7.1 m 23'											*7600 <b>*16,800</b>	7600 <b>16,800</b>
6.1 m 20'	8.1 m 26'							*7850 <b>*17,300</b>	6600 <b>14,600</b>			*7450 <b>*16,400</b>	5950 <b>13,100</b>
4.6 m 15'	8.7 m 28'			*12650 <b>*27,800</b>	*12650 <b>*27,800</b>	*9750 <b>*21,500</b>	9250 <b>20,400</b>	*8250 <b>*18,100</b>	6450 <b>14,200</b>			*7650 <b>*16,800</b>	5100 <b>11,300</b>
3.0 m 10'	9.0 m 29'			*15100 <b>*33,300</b>	13500 <b>29,800</b>	*11050 <b>*24,400</b>	8750 <b>19,300</b>	*8900 <b>*19,700</b>	6150 <b>13,600</b>	7250 <b>16,000</b>	4550 <b>10,000</b>	7450 <b>16,400</b>	4700 <b>10,300</b>
1.5 m 5'	9.0 m 30'			*15100 <b>*33,300</b>	12650 <b>27,800</b>	*12100 <b>*26,700</b>	8300 <b>18,300</b>	*9400 <b>*20,700</b>	5950 <b>13,100</b>	7150 <b>15,700</b>	4450 <b>9,800</b>	7250 <b>16,000</b>	4550 <b>10,000</b>
0 m 0'	8.8 m 29'			*16000 <b>*35,300</b>	12300 <b>27,200</b>	*12400 <b>*27,300</b>	8000 <b>17,700</b>	9300 <b>20,500</b>	5750 <b>12,700</b>	7050 <b>15,600</b>	4350 <b>9,600</b>	7450 <b>16,500</b>	4600 <b>10,200</b>
-1.5 m -5'	8.3 m 27'			*15950 <b>*35,200</b>	12350 <b>27,300</b>	*12050 <b>*26,600</b>	7900 <b>17,400</b>	9250 <b>20,400</b>	5700 <b>12,600</b>			*8100 <b>*17,800</b>	5050 <b>11,100</b>
-3.0 m -10'	7.5 m 24'	*17050 <b>*37,600</b>	*17050 <b>*37,600</b>	*14050 <b>*31,000</b>	12550 <b>27,700</b>	*10800 <b>*23,800</b>	8000 <b>17,600</b>	*7800 <b>*17,200</b>	5800 <b>12,700</b>			*8000 <b>*17,700</b>	5950 <b>13,100</b>
-4.6 m -15'	6.1 m 20'	*12800 <b>*28,200</b>	*12800 <b>*28,200</b>	*10750 <b>*23,700</b>	*10750 <b>*23,700</b>	*7900 <b>*17,400</b>	*7900 <b>*17,400</b>					*7350 <b>*16,300</b>	*7350 <b>*16,300</b>

PC300LC-8		Shoe 850 mm 33.5"										Unit: kg/lb	
B	A MAX	3.0 m 10'		4.6 m 15'		6.1 m 20'		7.6 m 25'		9.1 m 30'		⊗ MAX	
		Cf	Cs	Cf	Cs	Cf	Cs	Cf	Cs	Cf	Cs	Cf	Cs
7.6 m 25'	7.1 m 23'											*7600 <b>*16,800</b>	*7600 <b>*16,800</b>
6.1 m 20'	8.1 m 26'							*7850 <b>*17,300</b>	6650 <b>14,700</b>			*7450 <b>*16,400</b>	6000 <b>13,200</b>
4.6 m 15'	8.7 m 28'			*12650 <b>*27,800</b>	*12650 <b>*27,800</b>	*9750 <b>*21,500</b>	9300 <b>20,500</b>	*8250 <b>*18,100</b>	6450 <b>14,300</b>			*7650 <b>*16,800</b>	5150 <b>11,300</b>
3.0 m 10'	9.0 m 29'			*15100 <b>*33,300</b>	13600 <b>30,000</b>	*11050 <b>*24,400</b>	8800 <b>19,400</b>	*8900 <b>*19,700</b>	6200 <b>13,700</b>	7300 <b>16,100</b>	4600 <b>10,100</b>	7500 <b>16,500</b>	4700 <b>10,400</b>
1.5 m 5'	9.0 m 30'			*15100 <b>*33,300</b>	12700 <b>28,000</b>	*12100 <b>*26,700</b>	8350 <b>18,400</b>	*9400 <b>*20,700</b>	5950 <b>13,100</b>	7200 <b>15,800</b>	4450 <b>9,900</b>	7300 <b>16,100</b>	4550 <b>10,000</b>
0 m 0'	8.8 m 29'			*16000 <b>*35,300</b>	12400 <b>27,300</b>	*12400 <b>*27,300</b>	8050 <b>17,800</b>	9350 <b>20,700</b>	5800 <b>12,800</b>	7100 <b>15,700</b>	4400 <b>9,700</b>	7500 <b>16,600</b>	4650 <b>10,300</b>
-1.5 m -5'	8.3 m 27'			*15950 <b>*35,200</b>	12450 <b>27,400</b>	*12050 <b>*26,600</b>	7950 <b>17,500</b>	*9250 <b>*20,400</b>	5750 <b>12,600</b>			*8100 <b>*17,800</b>	5050 <b>11,200</b>
-3.0 m -10'	7.5 m 24'	*17050 <b>*37,600</b>	*17050 <b>*37,600</b>	*14050 <b>*31,000</b>	12600 <b>27,800</b>	*10800 <b>*23,800</b>	8050 <b>17,700</b>	*7800 <b>*17,200</b>	5800 <b>12,800</b>			*8000 <b>*17,700</b>	6000 <b>13,200</b>
-4.6 m -15'	6.1 m 20'	*12800 <b>*28,200</b>	*12800 <b>*28,200</b>	*10750 <b>*23,700</b>	*10750 <b>*23,700</b>	*7900 <b>*17,400</b>	*7900 <b>*17,400</b>					*7350 <b>*16,300</b>	*7350 <b>*16,300</b>

\*Load is limited by hydraulic capacity rather than tipping. Ratings are based on SAE standard No. J1097. Rated loads do not exceed 87% of hydraulic lift capacity or 75% of tipping load.

# PC300LC-8 HYDRAULIC EXCAVATOR

## LIFTING CAPACITIES



### LIFTING CAPACITY

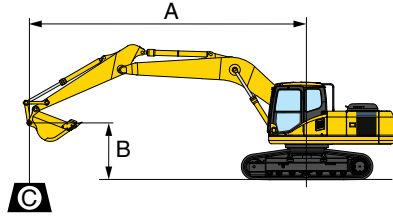

- A: Reach from swing center
- B: Bucket hook height
- C: Lifting capacity
- Cf: Rating over front
- Cs: Rating over side
- ⊗: Rating at maximum reach

#### Conditions:

- Arm: 3185 mm 10'5"
- Boom length 6500 mm 21'3"
- Bucket 1.4 m<sup>3</sup> 1.83 yd<sup>3</sup> (SAE heaped)
- Bucket weight: 1014 kg 2,235 lb.

PC300LC-8		Shoe 700 mm 28"										Unit: kg/lb	
B	A MAX	3.0 m 10'		4.6 m 15'		6.1 m 20'		7.6 m 25'		9.1 m 30'		⊗ MAX	
		Cf	Cs	Cf	Cs	Cf	Cs	Cf	Cs	Cf	Cs	Cf	Cs
7.6 m 25'	7.7 m 25'							*6050 *13,400	*6050 *13,400			*5350 *11,800	*5350 *11,800
6.1 m 20'	8.7 m 28'							*7200 *15,800	6700 14,700			*5250 *11,600	5250 11,600
4.6 m 15'	9.2 m 30'					*9050 *19,900	*9050 *19,900	*7700 *17,000	6500 14,300	*6850 *15,100	4650 10,300	*5350 *11,800	4550 10,100
3.0 m 10'	9.5 m 31'			*14550 *32,100	13900 30,600	*10450 *23,000	8850 19,500	*8500 *18,700	6200 13,700	7200 15,900	4550 10,000	*5700 *12,500	4200 9,300
1.5 m 5'	9.6 m 31'			*16850 *37,200	12850 28,400	*11750 *25,900	8350 18,500	*9150 *20,100	5950 13,100	7050 15,600	4400 9,700	*6250 *13,800	4050 9,000
0 m 0'	9.4 m 31'			*17200 *37,900	12350 27,200	*12350 *27,200	8000 17,700	9250 20,400	5700 12,600	6950 15,300	4300 9,500	6700 14,700	4150 9,100
-1.5 m -5'	8.9 m 29'	*9950 *21,900	*9950 *21,900	*16700 *36,800	12200 26,900	*12300 *27,100	7850 17,300	9100 20,100	5600 12,400	6900 15,200	4250 9,400	7200 15,800	4450 9,800
-3.0 m -10'	8.1 m 27'	*17800 *39,200	*17800 *39,200	*15200 *33,500	12350 27,200	*11450 *25,300	7850 17,300	*8650 *19,100	5600 12,400			*7700 *16,900	5100 11,300
-4.6 m -15'	6.9 m 23'	*16150 *35,700	*16150 *35,700	*12500 *27,600	12500 27,500	*9400 *20,800	8050 17,700					*7500 *16,500	6650 14,600
-6.1 m -20'	6.4 m 21'			*7550 *16,700	*7550 *16,700								

PC300LC-8		Shoe 800 mm 31.5"										Unit: kg/lb	
B	A MAX	3.0 m 10'		4.6 m 15'		6.1 m 20'		7.6 m 25'		9.1 m 30'		⊗ MAX	
		Cf	Cs	Cf	Cs	Cf	Cs	Cf	Cs	Cf	Cs	Cf	Cs
7.6 m 25'	7.7 m 25'							*6050 *13,400	*6050 *13,400			*5350 *11,800	*5350 *11,800
6.1 m 20'	8.7 m 28'							*7200 *15,800	6750 14,900			*5250 *11,600	*5250 *11,600
4.6 m 15'	9.2 m 30'					*9050 *19,900	*9050 *19,900	*7700 *17,000	6550 14,400	*6850 *15,100	4750 10,400	*5350 *11,800	4600 10,200
3.0 m 10'	9.5 m 31'			*14550 *32,100	*13950 *30,700	*10450 *23,000	8950 19,700	*8500 *18,700	6250 13,800	*7300 *16,100	4600 10,200	*5700 *12,500	4250 9,400
1.5 m 5'	9.6 m 31'			*16850 *37,200	13000 28,700	*11750 *25,900	8450 18,600	*9150 *20,100	6000 13,200	7150 15,800	4450 9,800	*6250 *13,800	4100 9,100
0 m 0'	9.4 m 31'			*17200 *37,900	12450 27,500	*12350 *27,200	8100 17,900	9350 20,600	5800 12,800	7050 15,500	4350 9,600	6750 14,900	4200 9,200
-1.5 m -5'	8.9 m 29'	*9950 *21,900	*9950 *21,900	*16700 *36,800	12350 27,200	*12300 *27,100	7950 17,500	9200 20,300	5650 12,500	7000 15,400	4300 9,500	7250 16,000	4500 9,900
-3.0 m -10'	8.1 m 27'	*17800 *39,200	*17800 *39,200	*15200 *33,500	12450 27,500	*11450 *25,300	7950 17,500	*8650 *19,100	5700 12,500			*7700 *16,900	5200 11,400
-4.6 m -15'	6.9 m 23'	*16150 *35,700	*16150 *35,700	*12500 *27,600	*12500 *27,600	*9400 *20,800	8100 17,900					*7500 *16,500	6700 14,800
-6.1 m -20'	6.4 m 21'			*7550 *16,700	*7550 *16,700								

\*Load is limited by hydraulic capacity rather than tipping. Ratings are based on SAE standard No. J1097. Rated loads do not exceed 87% of hydraulic lift capacity or 75% of tipping load.





## LIFTING CAPACITY

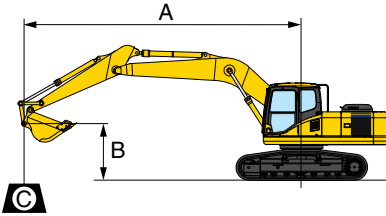

- A: Reach from swing center
- B: Bucket hook height
- C: Lifting capacity
- Cf: Rating over front
- Cs: Rating over side
- ⊗ : Rating at maximum reach

### Conditions:

- Arm: 3185 mm **10'5"**
- Boom length 6500 mm **21'3"**
- Bucket 1.4 m<sup>3</sup> **1.83 yd<sup>3</sup>** (SAE heaped)
- Bucket weight: 1014 kg **2,235 lb.**

PC300LC-8		Shoe 850 mm 33.5"										Unit: kg/lb	
A B	MAX	3.0 m 10'		4.6 m 15'		6.1 m 20'		7.6 m 25'		9.1 m 30'		⊗ MAX	
		Cf	Cs	Cf	Cs	Cf	Cs	Cf	Cs	Cf	Cs	Cf	Cs
7.6 m 25'	7.7 m 25'							*6050 *13,400	*6050 *13,400			*5350 *11,800	*5350 *11,800
6.1 m 20'	8.7 m 28'							*7200 *15,800	6800 15,000			*5250 *11,600	*5250 *11,600
4.6 m 15'	9.2 m 30'					*9050 *19,900	*9050 *19,900	*7700 *17,000	6600 14,500	*6850 *15,100	4750 10,500	*5350 *11,800	4650 10,200
3.0 m 10'	9.5 m 31'			*14550 *32,100	*13950 *30,700	*10450 *23,000	9000 19,800	*8500 *18,700	6300 13,900	*7300 *16,100	4650 10,200	*5700 *12,500	4300 9,400
1.5 m 5'	9.6 m 31'			*16850 *37,200	13050 28,800	*11750 *25,900	8500 18,700	*9150 *20,100	6000 13,300	7200 15,900	4500 9,900	*6250 *13,800	4150 9,100
0 m 0'	9.4 m 31'			*17200 *37,900	12550 27,600	*12350 *27,200	8150 18,000	9400 20,700	5800 12,800	7100 15,600	4350 9,700	6800 15,000	4200 9,300
-1.5 m -5'	8.9 m 29'	*9950 *21,900	*9950 *21,900	*16700 *36,800	12400 27,300	*12300 *27,100	7950 17,600	9250 20,500	5700 12,600	7050 15,500	4350 9,600	7300 16,100	4500 9,900
-3.0 m -10'	8.1 m 27'	*17800 *39,200	*17800 *39,200	*15200 *33,500	12500 27,600	*11450 *25,300	8000 17,600	*8650 *19,100	5700 12,600			*7700 *16,900	5200 11,500
-4.6 m -15'	6.9 m 23'	*16150 *35,700	*16150 *35,700	*12500 *27,600	*12500 *27,600	*9400 *20,800	8150 18,000					*7500 *16,500	6750 14,900
-6.1 m -20'	6.4 m 21'			*7550 *16,700	*7550 *16,700								

\*Load is limited by hydraulic capacity rather than tipping. Ratings are based on SAE standard No. J1097. Rated loads do not exceed 87% of hydraulic lift capacity or 75% of tipping load.

# PC300LC-8 HYDRAULIC EXCAVATOR

## LIFTING CAPACITIES



### LIFTING CAPACITY

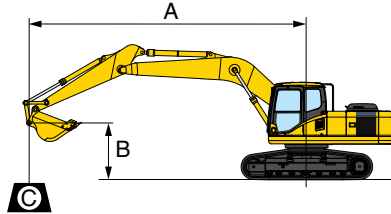

- A: Reach from swing center
- B: Bucket hook height
- C: Lifting capacity
- Cf: Rating over front
- Cs: Rating over side
- ⊗: Rating at maximum reach

#### Conditions:

- Arm: 4020 mm 13'2"
- Boom length 6500 mm 21'3"
- Bucket 1.4 m<sup>3</sup> 1.83 yd<sup>3</sup> (SAE heaped)
- Bucket weight: 1014 kg 2,235 lb.

PC300LC-8 Shoe 700 mm 28"															Unit: kg/lb	
B	A	MAX	1.5 m 5'		3.0 m 10'		4.6 m 15'		6.1 m 20'		7.6 m 25'		9.1 m 30'		⊗ MAX	
			Cf	Cs	Cf	Cs	Cf	Cs	Cf	Cs	Cf	Cs	Cf	Cs		
7.6 m 25'	8.8 m 29'														*4150 *9,200	*4150 *9,200
6.1 m 20'	9.6 m 31'												*5850 *12,900	4950 10,900	*4050 *9,000	*4050 *9,000
4.6 m 15'	10.1 m 33'									*7000 *15,500	6700 14,800	*6450 *14,200	4850 10,700	*4100 *9,100	3950 8,800	
3.0 m 10'	10.4 m 34'					*12600 *27,800	*12600 *27,800	*9450 *20,900	9100 20,100	*7900 *17,400	6350 14,100	*6850 *15,100	4700 10,300	*4300 *9,500	3700 8,100	
1.5 m 5'	10.4 m 34'					*15550 *34,300	13200 29,100	*10950 *24,200	8550 18,800	*8650 *19,100	6050 13,300	7150 15,800	4500 9,900	*4650 *10,200	3550 7,800	
0 m 0'	10.2 m 34'			*6100 *13,400	*6100 *13,400	*16850 *37,200	12400 27,300	*11950 *26,400	8050 17,800	*9250 *20,400	5750 12,700	7000 15,400	4300 9,500	*5150 *11,400	3600 7,900	
-1.5 m -5'	9.8 m 32'	*7000 *15,400	*7000 *15,400	*10000 *22,100	*10000 *22,100	*16900 *37,300	12000 26,500	*12250 *27,000	7800 17,100	9100 20,000	5550 12,300	6900 15,200	4200 9,300	*6000 *13,200	3800 8,400	
-3.0 m -10'	9.1 m 30'	*10100 *22,200	*10100 *22,200	*15900 *35,100	*15900 *35,100	*16050 *35,400	12000 26,400	*11900 *26,200	7700 17,000	9000 19,900	5500 12,200	6850 15,200	4200 9,300	*6950 *15,300	4250 9,400	
-4.6 m -15'	8.0 m 26'	*15200 *33,500	*15200 *33,500	*19500 *43,000	*19500 *43,000	*14100 *31,100	12200 26,900	*10600 *23,300	7800 17,200	*7850 *17,400	5600 12,400			*6950 *15,300	5200 11,400	
-6.1 m -20'	6.4 m 21'			*14000 *30,900	*14000 *30,900	*10550 *23,300	*10550 *23,300	*7650 *16,900	*7650 *16,900					*6450 *14,200	*6450 *14,200	

PC300LC-8 Shoe 800 mm 31.5"															Unit: kg/lb	
B	A	MAX	1.5 m 5'		3.0 m 10'		4.6 m 15'		6.1 m 20'		7.6 m 25'		9.1 m 30'		⊗ MAX	
			Cf	Cs	Cf	Cs	Cf	Cs	Cf	Cs	Cf	Cs	Cf	Cs		
7.6 m 25'	8.8 m 29'														*4150 *9,200	*4150 *9,200
6.1 m 20'	9.6 m 31'												*5850 *12,900	5000 11,000	*4050 *9,000	*4050 *9,000
4.6 m 15'	10.1 m 33'									*7000 *15,500	6750 14,900	*6450 *14,200	4900 10,800	*4100 *9,100	4000 8,900	
3.0 m 10'	10.4 m 34'					*12600 *27,800	*12600 *27,800	*9450 *20,900	9200 20,300	*7900 *17,400	6450 14,200	*6850 *15,100	4750 10,400	*4300 *9,500	3700 8,200	
1.5 m 5'	10.4 m 34'					*15550 *34,300	13350 29,400	*10950 *24,200	8600 19,000	*8650 *19,100	6100 13,400	7250 16,000	4550 10,000	*4650 *10,200	3600 7,900	
0 m 0'	10.2 m 34'			*6100 *13,400	*6100 *13,400	*16850 *37,200	12500 27,600	*11950 *26,400	8150 18,000	*9250 *20,400	5800 12,800	7050 15,600	4350 9,600	*5150 *11,400	3650 8,000	
-1.5 m -5'	9.8 m 32'	*7000 *15,400	*7000 *15,400	*10000 *22,100	*10000 *22,100	*16900 *37,300	12150 26,700	*12250 *27,000	7850 17,300	9200 20,300	5650 12,400	6950 15,400	4250 9,400	*6000 *13,200	3850 8,500	
-3.0 m -10'	9.1 m 30'	*10100 *22,200	*10100 *22,200	*15900 *35,100	*15900 *35,100	*16050 *35,400	12100 26,700	*11900 *26,200	7750 17,100	9100 20,100	5600 12,300	6950 15,300	4250 9,400	*6950 *15,300	4300 9,500	
-4.6 m -15'	8.0 m 26'	*15200 *33,500	*15200 *33,500	*19500 *43,000	*19500 *43,000	*14100 *31,100	12300 27,200	*10600 *23,300	7900 17,400	*7850 *17,400	5650 12,500			*6950 *15,300	5250 11,600	
-6.1 m -20'	6.4 m 21'			*14000 *30,900	*14000 *30,900	*10550 *23,300	*10550 *23,300	*7650 *16,900	*7650 *16,900					*6450 *14,200	*6450 *14,200	

\*Load is limited by hydraulic capacity rather than tipping. Ratings are based on SAE standard No. J1097. Rated loads do not exceed 87% of hydraulic lift capacity or 75% of tipping load.



## LIFTING CAPACITY

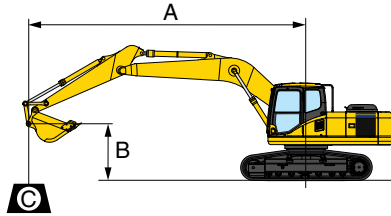

- A: Reach from swing center
- B: Bucket hook height
- C: Lifting capacity
- Cf: Rating over front
- Cs: Rating over side
- ⊗: Rating at maximum reach

### Conditions:

- Arm: 4020 mm 13'2"
- Boom length 6500 mm 21'3"
- Bucket 1.4 m<sup>3</sup> 1.83 yd<sup>3</sup> (SAE heaped)
- Bucket weight: 1014 kg 2,235 lb.

PC300LC-8		Shoe 850 mm 33.5"												Unit: kg/lb			
B	A	MAX	1.5 m 5'		3.0 m 10'		4.6 m 15'		6.1 m 20'		7.6 m 25'		9.1 m 30'		⊗ MAX		
			Cf	Cs	Cf	Cs	Cf	Cs	Cf	Cs	Cf	Cs	Cf	Cs			
7.6 m 25'	8.8 m 29'														*4150 *9,200	*4150 *9,200	
6.1 m 20'	9.6 m 31'													*5850 *12,900	5050 11,100	*4050 *9,000	*4050 *9,000
4.6 m 15'	10.1 m 33'										*7000 *15,500	6800 15,000	*6450 *14,200	4950 10,900	*4100 *9,100	4050 8,900	
3.0 m 10'	10.4 m 34'					*12600 *27,800	*12600 *27,800	*9450 *20,900	9250 20,400	*7900 *17,400	6450 14,300	*6850 *15,100	4750 10,500	*4300 *9,500	3750 8,300		
1.5 m 5'	10.4 m 34'					*15550 *34,300	13400 29,500	*10950 *24,200	8650 19,100	*8650 *19,100	6150 13,500	*7300 *16,100	4550 10,100	*4650 *10,200	3600 8,000		
0 m 0'	10.2 m 34'			*6100 *13,400	*6100 *13,400	*16850 *37,200	12550 27,700	*11950 *26,400	8200 18,100	*9250 *20,400	5850 12,900	7100 15,700	4400 9,700	*5150 *11,400	3650 8,100		
-1.5 m -5'	9.8 m 32'	*7000 *15,400	*7000 *15,400	*10000 *22,100	*10000 *22,100	*16900 *37,300	12200 26,900	*12250 *27,000	7900 17,400	9250 20,400	5650 12,500	7000 15,400	4300 9,500	*6000 *13,200	3850 8,500		
-3.0 m -10'	9.1 m 30'	*10100 *22,200	*10100 *22,200	*15900 *35,100	*15900 *35,100	*16050 *35,400	12200 26,900	*11900 *26,200	7800 17,200	*9150 *20,100	5600 12,400	*6950 *15,400	4300 9,500	*6950 *15,300	4350 9,500		
-4.6 m -15'	8.0 m 26'	*15200 *33,500	*15200 *33,500	*19500 *43,000	*19500 *43,000	*14100 *31,100	12400 27,300	*10600 *23,300	7900 17,500	*7850 *17,400	5700 12,600			*6950 *15,300	5300 11,600		
-6.1 m -20'	6.4 m 21'			*14000 *30,900	*14000 *30,900	*10550 *23,300	*10550 *23,300	*7650 *16,900	*7650 *16,900					*6450 *14,200	*6450 *14,200		

\*Load is limited by hydraulic capacity rather than tipping. Ratings are based on SAE standard No. J1097. Rated loads do not exceed 87% of hydraulic lift capacity or 75% of tipping load.



## STANDARD EQUIPMENT

- Alternator, 60 Ampere, 24V
- AM/FM radio
- Auto-decel
- Automatic air conditioner with defroster
- Automatic deaeration system for fuel line
- Automatic engine warm-up system
- Batteries, large capacity
- Boom and arm holding valves
- Cab, damper mounted
- Counterweight 7371 kg **16,246 lb**
- Dry type air cleaner, double element
- Electric horn
- EMMS monitoring system
- Engine, Komatsu SAA6D114E-3
- Engine overheat prevention system
- Fan guard structure
- Fuel system 10 micron pre-filter
- High pressure in-line hydraulic filters
- Hydraulic track adjusters (each side)
- KOMTRAX®
- Large 7" TFT LCD monitor panel
- Pattern change valve (S/N A90960 and up)
- Power maximizing system
- PPC hydraulic control system
- Radiator and oil cooler dustproof net
- Rearview camera (1)
- Rearview mirrors (LH & RH)
- Revolving frame deck guard
- Revolving frame undercovers
- Seat belt, 76 mm **3"** retractable
- Seat, suspension
- Service valve (1 additional)
- Shoes, triple grouser: 800 mm **31.5"**
- Slip resistant foot plates
- Starting motor 11 kW/24V x 1
- Suction fan
- Track guiding guard, center section
- Travel alarm
- Two boom mode settings
- Undercover for track frame center
- Working lights, 2 (boom and RH front)
- Working mode selection system



## OPTIONAL EQUIPMENT

- (1) Additional rearview camera
- Air ride suspension seat
- Arms
  - 2540 mm **8'4"** arm assembly
  - 3185 mm **10'5"** arm assembly
  - 3185 mm **10'5"** with one actuator piping
  - 4020 mm **13'2"** arm assembly
- Boom
  - 6500 mm **21'3"**
  - 6500 mm **21'3"** with one actuator piping
- Converter, 12V
- Full front guard Level 1
- Full front guard Level 2
- One actuator hydraulic control unit
- OPG top guard, Level 2, bolt-on
- Rain visor
- Revolving frame undercovers, heavy duty
- Shoes, triple grouser: 700 mm **28"**
- Shoes, triple grouser: 850 mm **33.5"**
- Straight travel pedal
- Sun visor
- Track frame undercover, heavy duty
- Track roller guards (full length)
- Working light, front, one additional



## ATTACHMENT OPTIONS

- JRB attachments
  - Boom cylinder guards
  - Couplers (Smart-Loc, Roto-Loc)
  - Swinger buckets
  - Top window guard (wire mesh)
  - Vandal protection guards
  - Window guards (Lexan®, wire mesh)
- Komatsu buckets
- Lincoln autolube systems
- PSM thumbs

For a complete list of available attachments, please contact your local Komatsu distributor.

**KOMATSU**®