

388HP | 7.3 – 8.1 yd³
BUCKET CAPACITY

 **Kawasaki**

9527



ONE FOCUS. COMPLETE SOLUTIONS.

INTRODUCING A NEW E.P.I.C. GENERATION

95Z7

95Z7 FEATURES:

- Fuel efficient Isuzu engine
- Powerful
- Total redesign, stylish
- Comfortable cab
- Great visibility
- Easy read LCD display
- Smooth shifting
- Quiet

EFFICIENT. POWERFUL. INTELLIGENT. COMFORTABLE.

Kawasaki pioneered the Z-Link design to provide unmatched utility, high breakout force and efficiency in its loaders. The Z7 generation implements brand-new patented technology, industry exclusive innovation, and input from owners and operators all over the world. We've engineered the Z7 series from the ground up!

EFFICIENT

Quick Cycle functions and PowerTrain Efficiencies work together through the IntelliTech Operating System to improve operating efficiency and reduce operating costs.

POWERFUL

Custom Operating Power Modes, made available through the IntelliTech Operating System, maximize a High Engine Power Rating to provide power on demand.

INTELLIGENT

The Kawasaki IntelliTech Operating System uses logic and intelligence to adjust the operating characteristics of the loader. Our intuitive system captures every aspect of working conditions and operating demands to adjust the powertrain and hydraulics for best application requirements. All of the IntelliTech features are designed to maximize performance.

COMFORTABLE

The new Z7 operator compartment features a low-profile dash, full-length glass doors, panoramic front window, standard rearview camera and well-organized storage areas — plus much more. We have total operator comfort in mind!



DEFINING A NEW STANDARD

Kawasaki defines a new standard in production class wheel loaders with the introduction of the 95Z7 — a model that reflects the advanced engineering required to improve operating efficiencies while lowering operating costs through a highly intuitive, patented technology, the IntelliTech System.

IntelliTech is a family of technological innovations by Kawasaki to enhance the performance of the Z7 loader series. It is a comprehensive package of features that affects all phases of the wheel loader application.

These features use logic or intelligence to adjust the operating characteristics of the machine, sensing the working conditions and adjusting the powertrain and hydraulics to best match application or environmental requirements. Many of the IntelliTech operations are automatic, while others allow the operator to select functions appropriate for the application or work environment.

- 24-Hour Parts Service
- In House Rebuild Center
- Flexible Warranty Programs
- Custom Dealer Service Programs



KCMA provides a totally focused approach to supporting your business. From carefully designed programs and services, to engineered special applications options, the 95Z7 wheel loader is ready to tackle the most demanding applications and environments.



EFFICIENT.

Efficiency is getting the job done with the least amount of waste. The Z7s are very efficient loaders. The hydraulic system is designed for maximum performance and efficiency. The systems and controls allow for efficient operation. And servicing is efficient and reduces operating costs even further.

EFFICIENT HYDRAULICS

- Industry Exclusive, open center system for better feel and response
- Fuel efficient, load sensing, piston pump hydraulics
- Excavator style system, proven performance
- Efficient, proven Z-linkage for excellent digging performance

EFFICIENT OPERATION

- Down Shift Switch allows for quick downshifting to meet operating conditions
- Shift Hold Switch allows for holding in range to meet operating conditions
- AutoMode provides for Automatic 1st–4th, 2nd–4th or manual for optimal operation
- Normal and Power modes match the full range of demand
- Quick Power button allows for momentary high power demand
- The Lock-up Clutch torque converter provides direct drive efficiency which translates into improved performance, and improved fuel efficiency.

- Traction Control adjusts engine speed to reduce tire spin, ultimately increasing tire life.

EFFICIENT SERVICING

- Extended Lube Intervals from patented HN bushings — up to 500 hours
- Extended Hydraulic Oil Change Interval — 4000 hours when using KCM SuperEX46 fluid
- Extended Engine Oil Change Interval — 500 hours when using low ash, CJ-4 oil
- Accessible filters, ground level fueling, tank sight gauges, grouped grease fittings



POWERFUL.

Power and productivity are what Kawasaki loaders are famous for. The Z7 has moved to another level in this area. Strong, responsive engines provide the power to get the job done. Powerful hydraulics make the work easy and the productivity high.

POWERFUL ENGINE

- Isuzu 6WG1 Diesel with a big 388 horsepower provides excellent power
- Tier 4i Certified, clean
- Reliable
- Fuel Efficient
- Responsive

POWERFUL HYDRAULICS

- Reliable piston pump
- Excellent breakout force
- Fast, Responsive
- Increased Steering Power



INTELLIGENT.



Intelligence in a wheel loader means systems that adjust to the working conditions to improve efficiency and productivity. The Kawasaki IntelliTech system is a family of features that optimize the performance of the machine in any working condition.

INTELLITECH SYSTEM

- Patented IntelliDig system balances Rimpull force and Hydraulic digging force to match conditions
- SimulLoad system allows for simultaneous actuation of lift and tilt while digging
- QuickCycle system speeds V-loading cycles
- FlexShift varies the shift points of the transmission to match working conditions

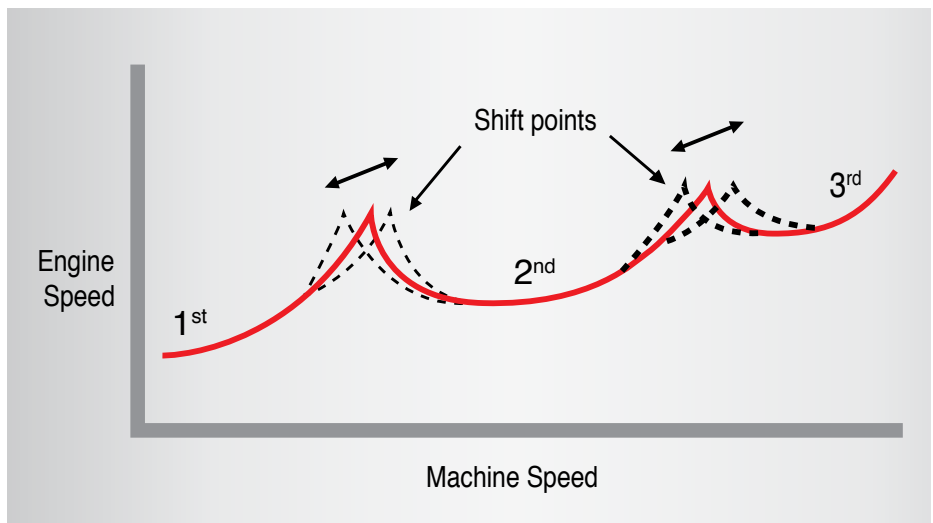

INTELLIGENT.



INTELLITECH SYSTEM

- Efficient Acceleration prevents wasted energy from over-accelerating and provides added power for fast acceleration
- Shockless Declutch provides smooth declutch function for level or slope operations
- Automatic Reversible Cooling Fan is controlled by multiple inputs for optimum operation
- Aerodynamic Fan blade design for quiet operation
- Auto Idle Shut Down senses excessive idling and shuts down engine to reduce fuel consumption and improve DPF performance



COMFORTABLE.

A comfortable operator is a productive operator. In the Kawasaki Z7s the operator comfort is outstanding. Quiet, convenient, clean, and designed for optimum operator comfort, safety, and productivity.

COMFORTABLE CAB

- Large, quiet, well-sealed ROPS cab with great visibility in all directions
- Deluxe, ergonomic air suspension seat can be equipped with heated cushions
- Standard rear, back-up camera supplements the dual interior and exterior mirrors
- Tilt/Telescoping steering column with pop-up pedal for convenient entry and exit
- High Visibility front dash design
- Excellent ventilation with sliding side windows.
- Adjustable side console to fit operator preference
- Standard AM/FM/CD/WB with AUX outlet and dual speakers
- Thermostatically controlled HVAC system for year-round climate control
- Convenient storage includes thermal storage box, cup holders, coat hook and large storage shelf



COMFORTABLE.

Improved Controllability. The full color LCD multi function instrument panel clearly provides information derived from IntelliTech, including machine operation and settings, plus HVAC controls, and fluid pressures. The monitor is very easy to see, as well as comprehend – the operator has several languages to choose from!

CONVENIENT CONTROLS

- Multi-function instrument panel provides information and allows for control, adjustments and alerts
- Fingertip, Pilot-assisted hydraulic controls can be single or dual lever
- The Pilot controls, available in single or dual lever, also contain fingertip controls for the DSS (Downshift Switch), Quick Power Button, and Horn.
- An alternate Shift Hold Button is conveniently located in the hydraulic control console, along with the elevated forward/reverse switch.
- The adjustable arm console contains rocker switches for convenient selection of the “Power Mode,” “Automode 1 & 2,” “Variable Declutch,” “Manual DPF Regen,” “Control Lever Lock” and optional “Ride Control.”
- Adjustable Side console to fit operator preference
- 12V outlet and 24V lighter outlet, dual interior lights
- Joystick Steering, Optional (with steering wheel)
- 3rd Spool Hydraulics, Optional



SERVICE SIMPLIFIED

EASY ACCESS

- Angled Ladders
- Wide-Access Engine Compartment Doors
- Easy-access cooling fan
- Battery Disconnect
- Easy Access Battery Box
- Grouped Lube Points
- Ground Level Hydraulic Sight Gauge
- Circuit Breaker Panel in Cab
- Autolube, Optional

- Automatic Reversible Cooling Fan, standard

- Ground Level Fueling

EXTENDED SERVICE INTERVALS

- HN Bushings impregnated with high viscosity oil extend lubrication period to 500 hours on loader linkage pins
- Extended Hydraulic Oil Change Interval
- Extended Engine Oil Change Interval



BUCKET DATA

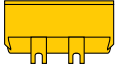
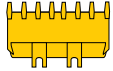
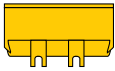

			Standard Boom		
			General Purpose		Material Handling
			Straight Edge With Bolt-on Cutting Edge	Straight Edge With Teeth & Segments	Straight Edge With Bolt-on Cutting Edge
					
Capacity	Heaped	yd ³ (m ³)	7.3 (5.6)	7.3 (5.6)	8.1 (6.2)
	Struck	yd ³ (m ³)	6.2 (4.7)	6.2 (4.7)	6.9 (5.3)
Maximum dumping clearance		ft-in (mm)	10 ⁹ / ₄ " (3,295)	10'5" (3,175)	10'7" (3,225)
Dumping reach (to front of bucket edge or tooth)		ft-in (mm)	4 ⁹ / ₄ " (1,455)	5 ⁹ / ₈ " (1,535)	5 ¹ / ₄ " (1,530)
Max. hinge pin height		ft-in (mm)	15 ³ / ₄ " (4,655)	15 ³ / ₄ " (4,655)	15 ³ / ₄ " (4,655)
Digging depth (with bucket level)		ft-in (mm)	5 ⁹ / ₈ " (135)	6 ¹ / ₄ " (160)	5 ⁹ / ₈ " (135)
Breakout force		lb (kN)	53,730 (239)	53,730 (239)	50,360 (224)
Bucket tilt-back angle	at ground level	degree	41°	41°	41°
	at carry position	degree	50°	50°	50°
Overall	Length	ft-in (mm)	31 ⁹ / ₈ " (9,700)	32 ³ / ₈ " (9,840)	32 ¹ / ₈ " (9,800)
	Height (to top of Cab/ROPS)	ft-in (mm)	12 ² / ₈ " (3,730)	12 ² / ₈ " (3,730)	12 ² / ₈ " (3,730)
	Height (bucket fully raised)	ft-in (mm)	20 ¹⁰ / ₇ " (6,370)	20 ¹⁰ / ₇ " (6,370)	21 ⁵ / ₂ " (6,540)
	Width (outside tire)	ft-in (mm)	10 ⁶ / ₄ " (3,220)	10 ⁶ / ₄ " (3,220)	10 ⁶ / ₄ " (3,220)
	Width (outside bucket)	ft-in (mm)	11 ³ / ₇ " (3,450)	11'6" (3,505)	11 ³ / ₇ " (3,450)
Tread		ft-in (mm)	8' (2,440)	8' (2,440)	8' (2,440)
Wheel base		ft-in (mm)	11 ⁹ / ₄ " (3,600)	11 ⁹ / ₄ " (3,600)	11 ⁹ / ₄ " (3,600)
Clearance Circle (bucket carry position)	at outside of bucket	ft-in (mm)	51'5" (15,670)	51'8 ¹ / ₂ " (15,760)	51'6 ⁷ / ₈ " (15,720)
	at outside tire	ft-in (mm)	45'10 ⁹ / ₄ " (13,990)	45'10 ⁹ / ₄ " (13,990)	45'10 ⁹ / ₄ " (13,990)
Minimum ground clearance		ft-in (mm)	1'5 ⁹ / ₈ " (440)	1'5 ⁹ / ₈ " (440)	1'5 ⁹ / ₈ " (440)
Full articulation angle		degree	37°	37°	37°
Operating weight (with ROPS Cab)		lb (kg)	75,790 (34,380)	75,840 (34,400)	76,390 (34,650)
Static Tipping Load (with ROPS cab)	Straight	lb (kg)	55,090 (24,990)	55,030 (24,960)	53,130 (24,100)
	Full turn	lb (kg)	47,990 (21,770)	47,950 (21,750)	46,300 (21,000)

The weight and load figure includes optional counterweight, enclosed ROPS Cab, air conditioner, 29.5R25 (L-3) tires, full fuel tank and operator.

Materials and specifications are subject to change without notice and without obligation on the part of the manufacturer. The specifications supplied, while believed to be completely reliable, are not to be taken as warranty for which we assume legal responsibility.

WEIGHTS AND DIMENSIONS

		Operating Weight	Tipping Load			Overall Width (Outside Tire)	Overall Height	Overall Length
			Straight	Full Turn				
Remove ROPS Cab (for transport only)	lb (kg)	-1,540 (-700)	-1,370 (-620)	-1,190 (-540)	in (mm)			
Remove Optional Counterweight	lb (kg)	-1,170 (-530)	-2,730 (-1,240)	-2,380 (-1,080)	in (mm)			
Tires: 29.5-25-28PR (L-3)	lb (kg)	-660 (-300)	-485 (-220)	-420 (-190)	in (mm)			
29.5-25-28PR (L-5)	lb (kg)	+1,455 (+660)	+1060 (+480)	+930 (+420)	in (mm)	+9/8 (+10)	+15/8 (+40)	-11/8 (-30)
29.5R25* (L-3) with 75% CaCl2	lb (kg)	+4,190 (+1,900)	+3,040 (+1,380)	+2,650 (+1,200)	in (mm)			
Belly Guard (rear frame)	lb (kg)	+200 (+90)	+220 (+100)	+180 (+80)	in (mm)			

BUCKET SELECTION CHART

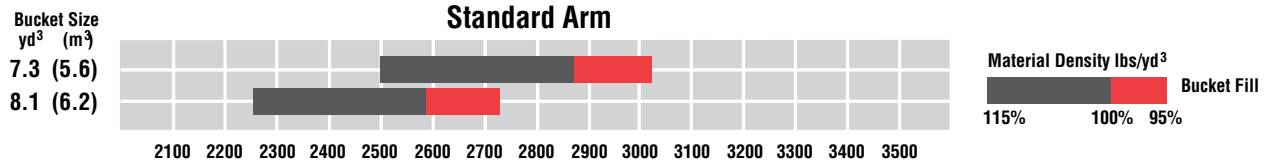

DIMENSIONS

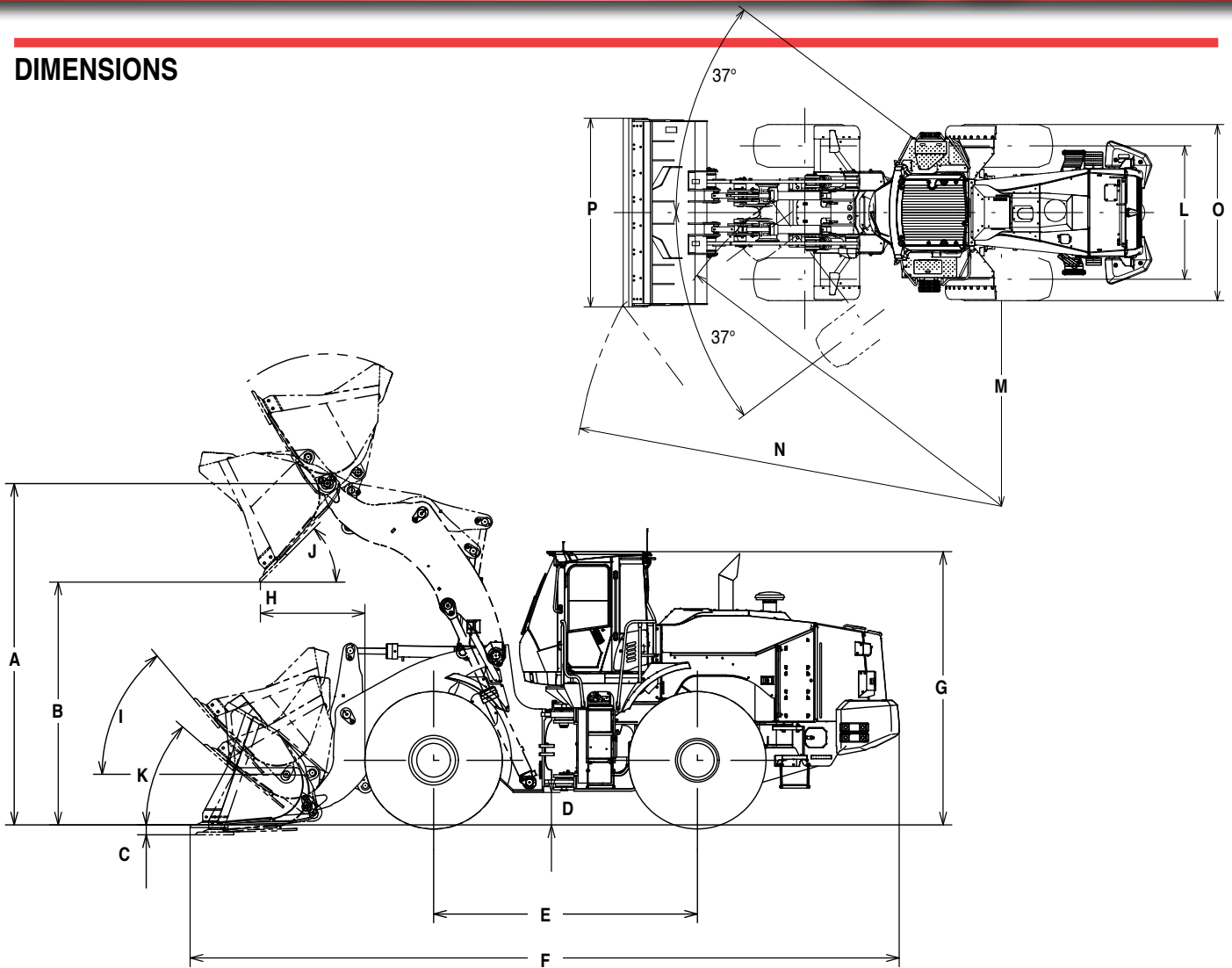

A	Hinge-Pin Height – Standard	15'3 ¹ / ₄ "	4,655 mm
B	Dumping Clearance	10'9 ³ / ₄ "	3,295 mm
C	Digging Depth	5 ³ / ₈ "	135 mm
D	Ground Clearance With 29.5R25 (See Tire Option Chart for Other Tires)	1'5 ³ / ₈ "	440 mm
E	Wheelbase	11'9 ³ / ₄ "	3,600 mm
F	Overall Length	31'9 ⁷ / ₈ "	9,700 mm
G	Height to Top of Cab/ROPS	12'2 ⁷ / ₈ "	3,730 mm
H	Dumping Reach – Standard	4'9 ¹ / ₄ "	1,455 mm
I	Tilt-Back @ Carry	50°	50°
J	Dump Angle @ Maximum Lift	45°	45°
K	Tilt-Back @ Ground	41°	41°
L	Tread	8'	2,440 mm

Clearance Circle – All dimensions are approximate and based on 29.5R25 (L-3) tires.

M	Clearance Circle to Outside of Tires	45'10 ³ / ₄ "	13,990 mm
N	Clearance Circle to Outside of Bucket	51'5"	15,670 mm
O	Width Over Tires	10'6 ³ / ₄ "	3,220 mm
P	Width to Outside Bucket	11'3 ⁷ / ₈ "	3,450 mm

ENGINE (EPA Tier 4 Interim/EU Stage IIIB certified)	
Gross Power (SAE J1995)	389 HP/1800 RPM (290 kW/1800RPM)
Net Power (SAE J1349) ISO 9249	388 HP/1800 RPM (289 kW/1800RPM)
Make/Model	Isuzu 6WG1 diesel engine
Type	4-cycle, water-cooled, direct injection with turbocharger and air cooled intercooler
Fuel Type	#2 Diesel (Requires ultra-low sulfur fuel.)
Fuel Injection Pump	Electronically controlled, common rail type
Governor	All speed electrical type
Cooling Module Type	Hydraulic-driven suction-type fan, pressurized radiator
Number of cylinders	6
Bore and stroke	5.787" x 6.063" (147mm x 154mm)
Total displacement	957 in ³ (15.68 liters)
Alternator	AC24V – 2.64kW (110 amp)
Air Cleaner	Dry type (double element)
Starter Motor	DC 24V 7.0 kW (9.4 HP)
Battery	12V – 200AH (1,300 CCA), 2 units

TORQUE CONVERTER AND TRANSMISSION	
Torque converter	3 elements, single stage, 1-phase w/lock-up clutch
Transmission	Planetary gear type, Full power shift. Autobrake protects transmission from overspeeding.
Speeds: Forward	1st: 3.8 MPH (6.1 km/hr) 2nd: 7.6 MPH (12.3 km/hr)* 3rd: 13.5 MPH (21.7 km/hr)* 4th: 23.6 MPH (38.0 km/hr)*
Speeds: Reverse	1st: 4.1 MPH (6.6 km/hr) 2nd: 7.6 MPH (12.3 km/hr) 3rd: 13.0 MPH (20.9 km/hr)

* indicates speed in lock-up

SYSTEMS REFILL CAPACITY		
LOCATION	GALLONS	LITERS
Fuel tank (diesel fuel)	115.7	438
Engine lubricant (including oil pan)	13.7	52
Engine coolant	18.0	68
T/M & T/C	18.5	70
Axle (front/rear)	29.0/29.0	110/110
Hydraulic oil tank	47.0	178
Hydraulic system (including hydraulic tank)	77.9	295

HYDRAULIC AND STEERING SYSTEM		
Steering type	Articulated frame steering	
Steering mechanism	Hydraulic power steering unit, pilot operated type	
Lift (boom) cylinder	Two (2) double-acting piston type: 6.229" x 40.433" (160mm x 1027mm)	
Tilt (bucket) cylinder	Two (2) double-acting piston type: 5.118" x 25.827" (130mm x 656mm)	
Steering cylinder	Two (2) double-acting piston type: 3.543" x 23.662" (90mm x 600mm)	
Main oil pump	Variable piston type: 89.8 GPM/1000 PSI @ 1800 RPM (340 LPM/6.9MPa @ 1800 RPM)	
Pilot oil pump	Variable piston type: 23.8 GPM/3260 PSI @ 1800 RPM (90 LPM/22.5 MPa @ 1800 RPM)	
Relief valve set pressure	Loading	4554 psi, 31.4 MPa (320 kg/cm ²)
	Steering	3989 psi, 27.5 MPa (280 kg/cm ²)
HYDRAULIC CYCLE TIME* front end loading, Z bar linkage system		
Lifting time (at full load)	6.5 sec.	
Lowering time (empty)	4.5 sec.	
Bucket dumping time	1.2 sec.	
TOTAL	12.2 sec.	

* Measured in accordance with SAE J732C

AXLE SYSTEM	
Drive system	4-wheel drive
Front and rear axle	Full-floating type
Tires	29.5-25-28PR (L-3)
	29.5-25-28PR (L-5)
	29.5R25 (L-3)
	29.5R25 (L-5)
Reduction and differential gear	Spiral bevel gear, torque proportioning, single stage reduction
Final reduction gear	Outboard mounted, internal planetary gear
Oscillation angle	±12°

BRAKE SYSTEM	
Service brakes	4 wheel, wet multiple disc brake. Mid-mount. Controlled by full hydraulic system. Dual circuit.
Parking/Emergency brake	Spring-applied, oil pressure-released. Located on driveline.

STANDARD EQUIPMENT

Engine

Air cleaner, double element
 Auto Idle Shut Down
 Cold Start (Glow Plug)
 Cooling Fan, Automatic Reversible
 Diesel particulate filter (Exhaust filter)
 EGR System

Fuel filter, w/water separator
 Fuel Pre-Filter, w/water separator
 Isuzu 6WG1 diesel engine
 Pre-cleaner (turbine type)
 VGT (Variable Geometry Turbocharger)
 Work mode selector

Powertrain

Autobrake
 Brakes, Service
 Enclosed Wet Disc
 Dual System
 Mid-Mount
 Brake, Parking
 Spring Applied
 Oil Pressure Released
 Wet Disc Type
 Down-Shift switch
 Differential, Torque proportioning type (F/R)
 Drive shafts, Low maintenance

F-R direction selector (2-Column mounted/Console mounted)
 Lock-up torque converter
 Quick Power switch
 Traction control
 Transmission, Automatic w/load sensing system.
 Transmission declutch (3-position L/H/Off)
 Transmission mode selection (3-position AUTO1/MAN/AUTO2)
 Universal Joints, Sealed

Hydraulic System

Boom Kick-Out, Dual (Operator adjustable in Cab)
 Bucket Positioner
 Control Lever, Dual, Pilot-assisted
 Control lever lock (Electric)
 Control Valve, 2-spool, Tandem Control

Pump, Variable Displacement, Load-sensing
 Steering, Pilot
 System; Open-Center, High-Pressure, Torque-Controlled

Electrical

24-volt electrical system
 Back-up alarm
 Batteries (2), 12V, 1,300 CCA
 Battery disconnect switch
 Camera, Rear-View
 Converter, 12V/15 Amp
 Horn, Dual Electric

Instrument Panel, LCD, Color
 Lights:
 2 Headlights (Halogen)
 2 Forward Working Lights
 4 Rear Working Lights
 2 Stop/Tail/Backup (LED)
 Turn signal w/4-way flashers/Marker

Cab

ROPS Cab: Enclosed cab with sound suppression, front & rear wipers and washers, two rear view and side mirrors, tinted glass, front hinge doors, sliding side windows.
 Accessory Outlet, 12V,
 Adjustable Armrest/Console, (fore/aft sliding)
 Air Conditioner/Heater/Pressurizer
 AM/FM/CD/WB radio with AUX input
 Ashtray
 Cab Dome Lamps (2)
 Cigarette Lighter, 24V

Coat Hook
 Cup Holder (2)
 Floormat, Sweep-out
 Retractable seat belt (3 inch)
 ROPS/FOPS Certified
 Seat, Air Suspension, fabric
 Steering Column, Telescoping and Tilting w/quick-release pedal
 Storage Box (Heated/Cooled)
 Storage Tray
 Sun Visor

Alarms, Gauges and Indicators

Alarms(Visual & Audible)
 Air cleaner element
 Axle oil temperature
 Battery discharge warning
 Boost temperature/ Boost temperature difference
 Brake oil low pressure
 EGR gas temperature
 Engine oil low pressure
 Engine warning
 Exhaust gas temperature
 Fuel temperature
 Fuel filter (Plugged Filter)
 Fuel filter (Water in fuel)
 Hydraulic oil level
 Hydraulic oil temperature
 Intake Air temperature
 Main pump oil pressure
 Overheat (Engine coolant)
 Transmission warning

Speedometer
 Tachometer
 Transmission oil temperature

Gauges
 Brake oil pressure
 Engine coolant temperature
 Fuel gauge

Indicators
 Air conditioner display
 Boom Kick-Out, Dual
 Cold Start
 Control lever lock
 Declutch
 Diesel particulate filter status
 Fan reverse rotation
 F-N-R Selection
 F-N-R Switch Enable
 High beam
 ECO-Operating Status
 Work mode (Normal, Power)
 Parking brake
 Shift hold
 Time/Operating hour/ODO
 Transmission mode and status
 Turn signal w/4-way flashers/Marker
 Work light

Others

Articulation locking bar
 Counterweight
 Drawbar
 Fenders, Front, w/mudflap
 Fenders, Rear, Full, w/mudflap
 Ladders, Inclined
 Lifting eyes

Linkage Pins, HN Bushing
 Neutral Safety Start
 Rear Grill, hinged
 Steps, rear
 Vandalism protection
 Z-bar loader linkage

OPTIONAL EQUIPMENT

Autolube
 Belly Guard, Transmission
 Bolt-On Cutting Edge & Segments
 Bucket Teeth

Counterweight, Optional
 High Lift Boom Arm
 Hydraulic System, 3 Spool Valve
 Joystick Steering

Quick Coupler & Attachments
 Ride Control, Automatic
 Seat, Heated

Single Lever Hydraulic Control w/multifunction Grip
 Secondary Steering

ONE FOCUS. COMPLETE SOLUTIONS.

THE KAWASAKI DIFFERENCE

It's the Kawasaki difference customers across North America look to — power, performance, reliability and a rich history of providing innovative solutions. Through its long-term commitment to maintaining a leadership position in technology, service and support, dedicated focus on a single product line and unsurpassed track record, Kawasaki continues to deliver. This means real benefits to your business: efficiency, increased production, reduced operating costs, comfort and across-the-board quality support.

- Dedicated Focus on Producing Wheel Loaders Since 1962
- Engineered Specialty Applications Packages
- Extensive Training at the KCMA Corporation Training Center and at Customer and Dealer Locations
- Flexible Warranty Programs
- Fully Equipped, in-house Rebuild Center
- 24-Hour Parts Shipments
- Carefully Designed Programs and Services

- Solid Partnerships with Knowledgeable, Experienced, Independent Dealers

HISTORY

KCMA's parent company, Kawasaki Heavy Industries, has been a global leader for more than 100 years at providing comprehensive solutions and quality, top-performing products. From aerospace to infrastructure to construction equipment, Kawasaki Heavy Industries sets the standard — all the while raising the bar.

FOCUS

Thanks to Kawasaki's total focus on articulated wheel loaders, your Kawasaki wheel loader is ready to tackle the most demanding applications and environments.

Even more, KCMA's fully equipped rebuild center, located in Kennesaw, Georgia, goes steps further by staffing skilled technicians armed with the in-depth knowledge and specialized equipment required to provide customers with first-class support.



INNOVATION

Working with end users across the globe, KCM engineers stay up to speed on reviewing wheel loader needs. The result: Kawasaki leads the way in responding to new industry demands with complete solutions, engineering and manufacturing Kawasaki wheel loaders that are up to the task — and your expectations.

KAWASAKI WHEEL LOADERS

- 15 Models
- .78–13.5 cu.yd.
- 45 HP–720 HP



KCM
KCMA Corporation

2140 Barrett Park Drive • Suite 101
Kennesaw, Georgia 30144
www.Kawasakiloaders.com
Tel: 770-499-7000
Fax: 770-421-6842

Part# 95Z7 BROCH (12/2012)